

Trhací nýty hliníkové standardní s plochou hlavou

DIN 7337

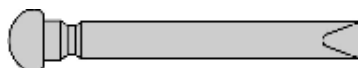





Hliník AlMg3,5%

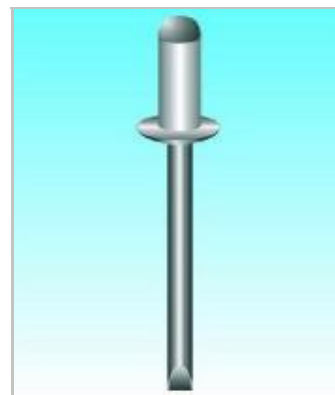



Ocel pozinkovaná

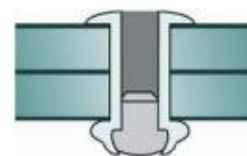
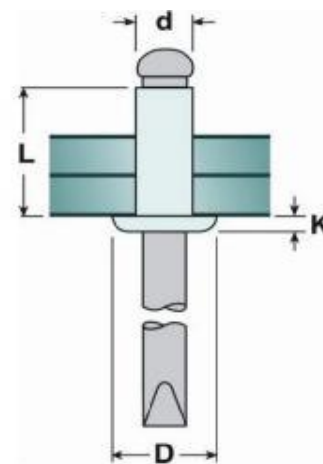

d mm	L mm	D mm	 mm	K mm	 mm			€ / 1000	N ^o
2,4	5,0	4,8	2,5	0,7	0,5 ÷ 2,5	1 000	8 000		10100 2405
2,4	6,0	4,8	2,5	0,7	1,5 ÷ 3,5	1 000	8 000		10100 2406
2,4	7,0	4,8	2,5	0,7	2,5 ÷ 4,5	1 000	8 000		10100 2407
2,4	9,0	4,8	2,5	0,7	3,5 ÷ 6,5	1 000	8 000		10100 2409
3,0	4,0	6,0	3,0	0,8	0,5 ÷ 1,5	1 000	8 000		10100 3004
3,0	5,0	6,0	3,0	0,8	0,5 ÷ 2,0	1 000	8 000		10100 3005
3,0	6,0	6,0	3,0	0,8	1,5 ÷ 3,0	1 000	8 000		10100 3006
3,0	8,0	6,0	3,0	0,8	3,0 ÷ 5,0	1 000	8 000		10100 3008
3,0	9,0	6,0	3,0	0,8	4,0 ÷ 6,0	1 000	8 000		10100 3009
3,0	10,0	6,0	3,0	0,8	5,0 ÷ 7,0	1 000	8 000		10100 3010
3,0	11,0	6,0	3,0	0,8	6,0 ÷ 8,0	1 000	8 000		10100 3011
3,0	12,0	6,0	3,0	0,8	7,0 ÷ 9,0	1 000	8 000		10100 3012
3,0	14,0	6,0	3,0	0,8	9,0 ÷ 11,0	1 000	8 000		10100 3014
3,0	16,0	6,0	3,0	0,8	11,0 ÷ 13,0	500	4 000		10100 3016
3,0	18,0	6,0	3,0	0,8	13,0 ÷ 15,0	500	4 000		10100 3018
3,2	5,0	6,5	3,3	0,9	0,5 ÷ 1,5	1 000	8 000		10100 3205
3,2	6,0	6,5	3,3	0,9	1,0 ÷ 2,5	1 000	8 000		10100 3206
3,2	7,0	6,5	3,3	0,9	1,5 ÷ 3,5	1 000	8 000		10100 3207
3,2	8,0	6,5	3,3	0,9	2,5 ÷ 4,5	1 000	8 000		10100 3208
3,2	10,0	6,5	3,3	0,9	4,5 ÷ 6,5	1 000	8 000		10100 3210
3,2	11,0	6,5	3,3	0,9	5,5 ÷ 7,5	1 000	8 000		10100 3211
3,2	12,0	6,5	3,3	0,9	6,5 ÷ 8,5	1 000	8 000		10100 3212
3,2	14,0	6,5	3,3	0,9	8,5 ÷ 10,5	500	4 000		10100 3214
3,2	16,0	6,5	3,3	0,9	10,5 ÷ 12,5	500	4 000		10100 3216
3,2	18,0	6,5	3,3	0,9	12,5 ÷ 14,5	500	4 000		10100 3218

Pokračování na následující straně



d mm		
2,4	485	353
3,0	926	662
3,2	1 058	837



Trhací nýty hliníkové standardní s plochou hlavou

DIN 7337





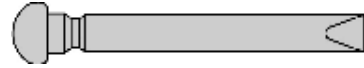

Hliník AlMg3,5%

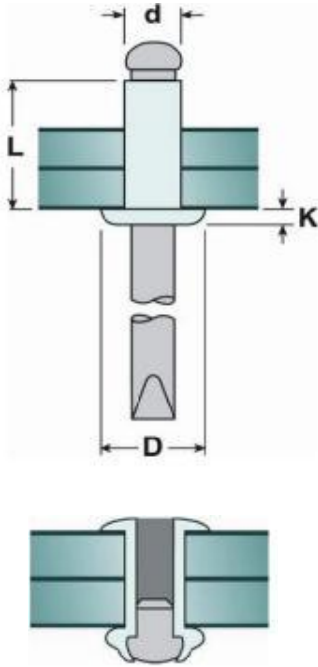

Ocel pozinkovaná



d mm	L mm	D mm	 mm	K mm	 mm			€ / 1000	N°
4,0	5,0	8,0	4,0	1,2	0,5 ÷ 1,5	1 000	8 000		10100 4005
4,0	6,0	8,0	4,0	1,2	1,0 ÷ 2,5	1 000	8 000		10100 4006
4,0	7,0	8,0	4,0	1,2	2,0 ÷ 3,5	1 000	8 000		10100 4007
4,0	8,0	8,0	4,0	1,2	3,0 ÷ 4,5	1 000	8 000		10100 4008
4,0	9,0	8,0	4,0	1,2	4,0 ÷ 5,5	1 000	8 000		10100 4009
4,0	10,0	8,0	4,0	1,2	5,0 ÷ 6,5	500	4 000		10100 4010
4,0	12,0	8,0	4,0	1,2	7,0 ÷ 8,5	500	4 000		10100 4012
4,0	14,0	8,0	4,0	1,2	8,0 ÷ 10,0	500	4 000		10100 4014
4,0	16,0	8,0	4,0	1,2	10,0 ÷ 11,0	500	4 000		10100 4016
4,0	18,0	8,0	4,0	1,2	11,0 ÷ 13,0	500	4 000		10100 4018
4,0	20,0	8,0	4,0	1,2	13,0 ÷ 15,0	500	4 000		10100 4020
4,0	25,0	8,0	4,0	1,2	18,0 ÷ 20,0	250	2 000		10100 4025
4,0	30,0	8,0	4,0	1,2	21,5 ÷ 26,0	250	2 000		10100 4030
4,8	6,0	9,5	5,0	1,4	0,5 ÷ 1,5	500	4 000		10100 4806
4,8	8,0	9,5	5,0	1,4	2,0 ÷ 3,5	500	4 000		10100 4808
4,8	10,0	9,5	5,0	1,4	4,0 ÷ 6,0	500	4 000		10100 4810
4,8	12,0	9,5	5,0	1,4	6,0 ÷ 8,0	500	4 000		10100 4812
4,8	14,0	9,5	5,0	1,4	8,0 ÷ 10,0	500	4 000		10100 4814
4,8	16,0	9,5	5,0	1,4	9,0 ÷ 11,0	500	4 000		10100 4816
4,8	18,0	9,5	5,0	1,4	11,0 ÷ 13,0	250	2 000		10100 4818
4,8	20,0	9,5	5,0	1,4	14,0 ÷ 15,0	250	2 000		10100 4820
4,8	22,0	9,5	5,0	1,4	15,0 ÷ 16,0	250	2 000		10100 4822
4,8	25,0	9,5	5,0	1,4	16,0 ÷ 19,0	250	2 000		10100 4825
4,8	27,0	9,5	5,0	1,4	19,0 ÷ 21,0	250	2 000		10100 4827
4,8	30,0	9,5	5,0	1,4	21,0 ÷ 24,0	200	1 600		10100 4830
4,8	35,0	9,5	5,0	1,4	24,0 ÷ 29,0	200	1 600		10100 4835
4,8	40,0	9,5	5,0	1,4	29,0 ÷ 34,0	200	1 600		10100 4840
4,8	45,0	9,5	5,0	1,4	34,0 ÷ 39,0	200	1 600		10100 4845
4,8	50,0	9,5	5,0	1,4	39,0 ÷ 44,0	200	1 600		10100 4850
4,8	55,0	9,5	5,0	1,4	44,0 ÷ 49,0	200	1 600		10100 4855

Pokračování na následující straně

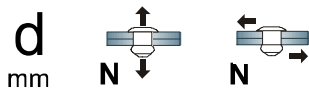

4,0	1 808	1 282
4,8	2 558	1 896

Trhací nýty hliníkové standardní s plochou hlavou

DIN 7337





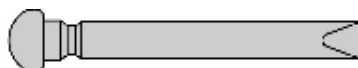

Hliník AlMg3,5%

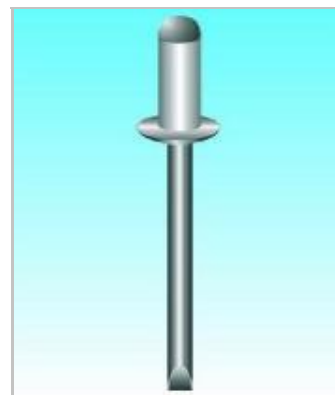



Ocel pozinkovaná

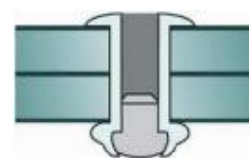
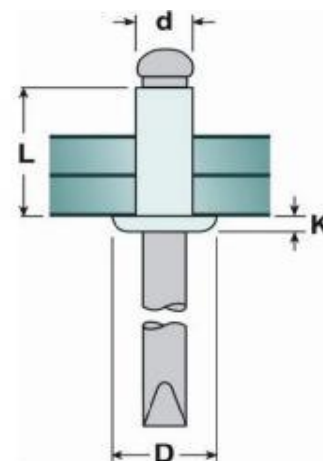

d mm	L mm	D mm	 mm	K mm	 mm			€ / 1000	N ^o
5,0	6,0	9,5	5,1	1,4	0,5 ÷ 1,5	500	4 000		10100 5006
5,0	8,0	9,5	5,1	1,4	3,0 ÷ 4,5	500	4 000		10100 5008
5,0	10,0	9,5	5,1	1,4	4,5 ÷ 6,0	500	4 000		10100 5010
5,0	12,0	9,5	5,1	1,4	6,0 ÷ 8,0	500	4 000		10100 5012
5,0	14,0	9,5	5,1	1,4	8,0 ÷ 10,0	500	4 000		10100 5014
5,0	16,0	9,5	5,1	1,4	10,0 ÷ 12,0	250	2 000		10100 5016
5,0	20,0	9,5	5,1	1,4	14,0 ÷ 16,0	250	2 000		10100 5020
5,0	25,0	9,5	5,1	1,4	16,0 ÷ 21,0	200	1 600		10100 5025
6,0	9,0	12,0	6,0	1,7	2,0 ÷ 4,0	250	2 000		10100 6009
6,0	10,0	12,0	6,0	1,7	3,5 ÷ 5,5	250	2 000		10100 6010
6,0	12,0	12,0	6,0	1,7	3,0 ÷ 6,0	250	2 000		10100 6012
6,0	14,0	12,0	6,0	1,7	4,5 ÷ 7,5	250	2 000		10100 6014
6,0	15,0	12,0	6,0	1,7	6,0 ÷ 9,0	250	2 000		10100 6015
6,0	16,0	12,0	6,0	1,7	7,5 ÷ 10,5	200	1 600		10100 6016
6,0	18,0	12,0	6,0	1,7	9,0 ÷ 12,0	200	1 600		10100 6018
6,0	22,0	12,0	6,0	1,7	12,0 ÷ 16,0	200	1 600		10100 6022
6,0	27,0	12,0	6,0	1,7	16,0 ÷ 21,0	200	1 600		10100 6027
6,0	32,0	12,0	6,0	1,7	21,0 ÷ 26,0	200	1 600		10100 6032
6,0	35,0	12,0	6,0	1,7	26,0 ÷ 30,0	200	1 600		10100 6035
6,4	10,0	13,0	6,5	2,0	2,0 ÷ 4,0	250	2 000		10100 6410
6,4	12,0	13,0	6,5	2,0	4,0 ÷ 6,0	250	2 000		10100 6412
6,4	16,0	13,0	6,5	2,0	6,0 ÷ 9,0	250	2 000		10100 6416
6,4	19,0	13,0	6,5	2,0	9,0 ÷ 12,0	250	2 000		10100 6419
6,4	25,0	13,0	6,5	2,0	12,0 ÷ 18,0	200	1 600		10100 6425



d mm		
5,0	2 950	2 170
6,0	4 145	3 043
6,4	5 116	3 263